

AP8a

Backplane for 5B modules

Capable connection technology. For eight 5B modules.

Carrier board in 5B technology: Up to eight measuring amplifiers, converters or any other function modules can be plugged into the analog backplane AP8a. The variety of available 5B modules provides for the solution of the most specific measuring tasks - individual and simple.

5B technology. Industrial standard.

The pin assignment of the backplane integrated in the AP8a corresponds to the 5B module standard of Analog Devices and Burr Brown. An additional 0EX pin has been introduced for sensors requiring unipolar supply.

Clearly safe.

Most of the 5B modules feature galvanic isolation of the channels from each other and from the data acquisition and control system. This perfectly protects the whole system against high potentials and interferences.

Well supplied.

The AP8a is operated with 5V or 9-40V optionally. The supply voltage is connected via screw-clamp terminals.

Signal connection. Clamp. Plug in. Ready.

Sensors or other voltage signals can comfortably be connected via 7-pole spring terminal blocks (ZU7ST), which are plugged in the relevant input connectors of the AP8a.

Connection to the DAQ system.

The amplifier outputs are available at a 16-pin plug connector. They are connected to the input lines of a data acquisition system. Combining the AP8a with a measuring card or DAQ system from bmcm makes a powerful measurement system.

DIN rail mounting.

The AP8a comes with a DIN rail carrier with bracket to be easily mounted on a standard DIN rail as commonly used in electrical installation.

The small option. You have the choice.

For all needing less channels: The analog backplane is also available as a 2-channel version AP2.

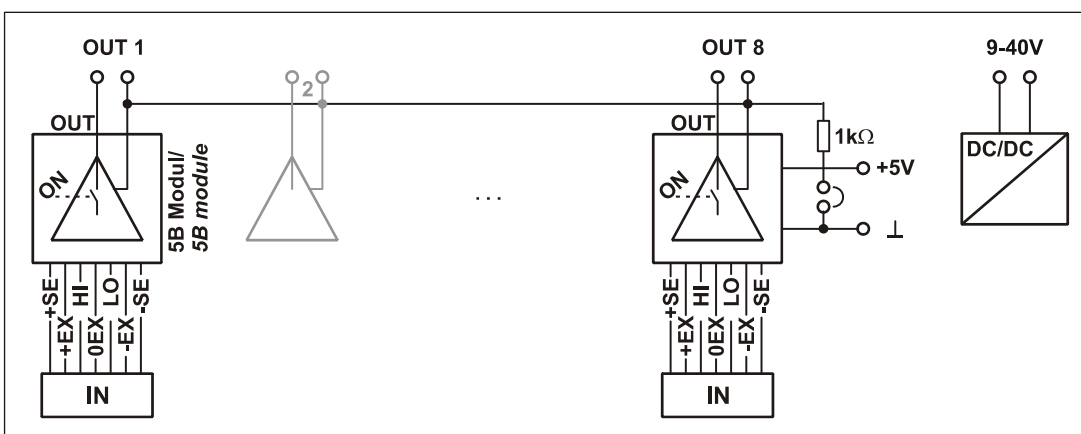

Functional diagram

1 Installation

Mount the AP8a into the DIN rail carrier and click it on the DIN rail. Provide for power supply by applying a 2-pole cable to the power unit. Now the analog output of the AP8a is connected with the DAQ system, the AP8a is equipped with 5B-compatible modules, and the signals cables are attached to the terminal blocks (available under: *ZU7ST*), which are plugged into the input connectors of the AP8a then.



Always turn off the power before changing the modules! Check for correct poling of the power supply!

2 Connections and pin assignments

The available connections and different components of the AP8a board are shown in the following figure of the board (view on top of the board (fitted with components), analog output connector top right).

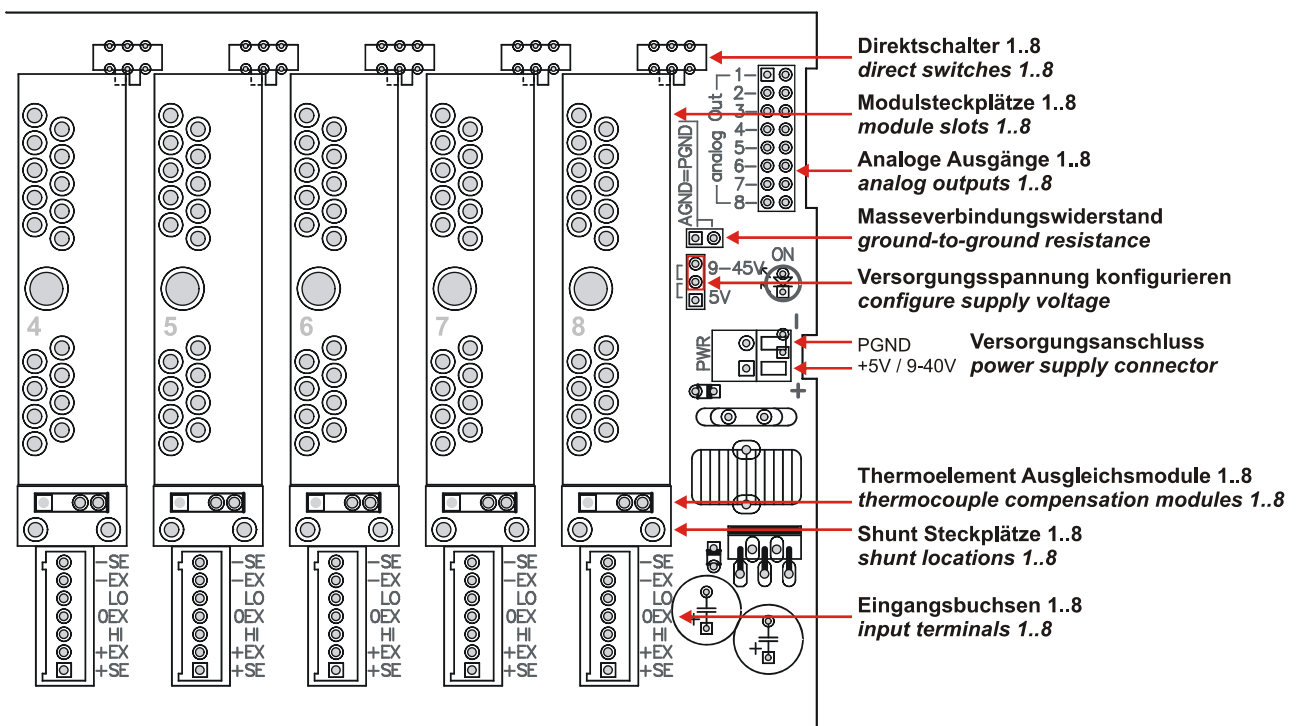
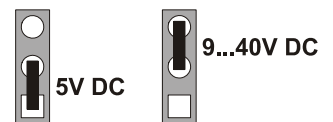

Figure 1

2.1 Power supply +5V or 9-40V

The power supply is applied to the 2-pole screw terminal of the AP8a (see Figure 1).

The range of the supply voltage is selected at the 3-pole jumper on the AP8a. If placed across the pad in the middle and the square pad, the backplane must be supplied with +5V. If placed across the pad in the middle and the round pad, a voltage in the range of +9..40V (default setting ex works) can be used.



The power supply is provided with a reversible semi-conductor fuse (multifuse), which is turned off when overloaded. To make the fuse work effectively again, get rid of the overload first before disconnecting the AP8a from the power supply.

2.2 Direct switch

The direct switch (see Figure 1) bridges the relevant module location. If the direct switch is on, an input channel can be used as a 2-pole voltage channel without a 5B measuring converter. A 5B module cannot be plugged in, the corresponding channel is not galvanically isolated.

2.3 Ground-to-ground resistance

The ground-to-ground resistance is required when the output ground is not electrically connected with the power supply ground. If the jumper "AGND=PGND" (see Figure 1) is closed, the output switches of the modules are switched through. In case of electrically connected systems (e.g. PC), this jumper represents a high-resistance bridge (1kΩ) and may generate a hum loop.

2.4 Analog OUT connector

The amplifier outputs are available at the 16-pole pin connector (see Figure 1). They are connected to the analog inputs of the data acquisition system.

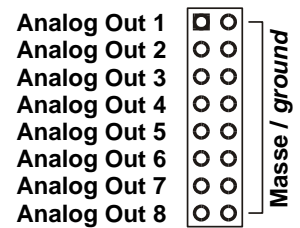

The output cable can be laid with the same signal ground and shield in case of short distances (long distances may lead to cross talk).

2.5 Input terminals

The measuring signals are connected to pins HI and LO of the input terminals (see Figure 1). Depending on the 5B module used, the +EX and -EX pins provide the relevant supply for the sensors. Pins +SE and -SE are sensor lines and are connected according to the relevant application (e.g. for 6-wire technology in strain gage measurement). the shield of the analog input cables can be applied to ground or 0EX depending on the application (always connect at one end of the cable only).

Comfortable connection to the input terminals is possible by using 7-pole spring terminal blocks available in a package of 8 (order number: ZU7ST).



Run the signal ground separately if possible. Always lay input cables separately.

2.6 Module pin assignment

The pin assignment on the right shows the top view of the module back-plane (see Figure 1).

The pin assignment corresponds to the 5B modules of Analog Devices®, BURR BROWN® etc. However, an additional 0EX pin has been introduced, which is particularly suitable for ungrounded shielding. This is a specific assignment of BMC Messsysteme GmbH. The 0EX pin is not connected in modules of other manufacturers.

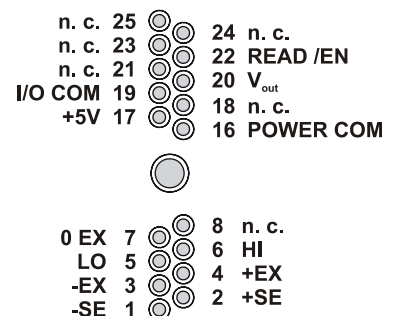

2.7 Current measurement modules

If a current measurement module requires an external shunt, it can be inserted in front of the relevant 5B module.

2.8 Thermocouple connection

Using a thermocouple requires a cold junction compensation. The relevant element is plugged underneath the module slot (see Figure 1). This allows the installation of a cold junction compensation directly at the terminal connection of the thermocouple matching the 5B modules.

3 Connection examples for using the AP8a with 5B amplifiers

The most different 5B amplifiers can be used with the AP8a. Please see the relevant data sheets of the 5B modules for further connection examples.

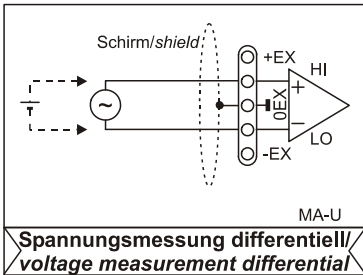

3.1 MA-U: Voltage measurement (DC and AC decoupled)

The input is differential (balanced).

Close jumpers J5 and J7 of the MA-U for AC decoupling to suppress DC components of the signal. AC decoupling can only be used in the $\pm 0.5V$ and $\pm 1V$ measuring range.

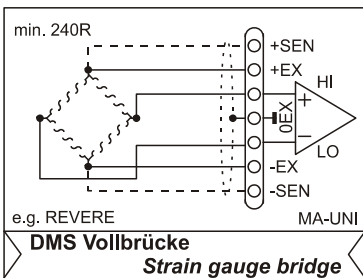

3.2 MA-UNI: Strain gage measurement with DC

Strain gages are resistors operated in bridge circuits. The EX voltage is $\pm 2.5V$ DC. The input amplifier is operated in differential mode. If necessary, the sensor lines compensate for line losses.

In the case of bridge extensions, precise supplementary resistors must be used (0.1%; TC15). If using 100Ω bridges, it is only possible to supply with $+2.5V$, dividing the measuring range in half.

The Jumpers J12, J13 of the MA-UNI must only be closed in 6-wire applications. For some applications, it is better to connect the screen to earth and not to the internal ground (0EX).

4 Important notes for using the AP8a

- The AP8a is only suitable for extra-low voltages – please observe the relevant regulations!
- An electrically isolated power unit (with CE) must be used for power supply.
- All accessible pins are electrostatic sensitive devices. Provide for an earthed conductive work place when installing.
- Only use non-solvent detergents for cleaning.
- The product is designed to be maintenance-free. For calibration, the backplane must be returned to bmcm.
- If using the direct switches, the relevant LO input is connected with the succeeding DAQ system and therefore may be connected to ground. Open inputs should be closed.
- The board must not be used for safety-relevant tasks. With the use of the product, the customer becomes manufacturer by law and is therefore fully responsible for the proper installation and use of the product. In the case of improper use and/or unauthorized interference, our warranty ceases and any warranty claim is excluded.



Do not dispose of the product in the domestic waste or at any waste collection places. It has to be either duly disposed according to the WEEE directive or can be returned to bmcm at your own expense.

5 Technical data (typical at 20°C, after 5min., 9-40V supply)

• Electrical data

Power supply:	9..40V (max. 1A DC, default setting ex works) or +5V DC $\pm 5\%$ (max. 1.5A DC)
Max. current to be drawn for the modules:	max. 1A (\approx total of current of all individual modules)
Electrical isolation:	depending on the module in use; in case of direct switching no electrical isolation!
Max. permissible potentials:	60V DC acc. to VDE , max. 1kV ESD on open lines

• General data

Temperature ranges // Relative humidity:	operating temp. 0..70°C, storage temp. -25..70°C // 0-90% (not condensing)
CE standards:	EN61000-6-1, EN61000-6-3, EN61010-1; for decl. of conformity (PDF) visit www.bmcm.de
ElektroG // ear registration:	RoHS and WEEE compliant // WEEE Reg.-No. DE75472248
Dimensions (L x W x H):	backplane: 18cm x 10cm x 2cm; with DIN rail carrier and bracket: 18.3cm x 10.5cm x 4.3cm
Available accessories (optional):	7-pole pluggable spring clamp terminals ZU7ST (package of 8), power supply ZU-PW10W, waterproof housing ZU-PBOX-PG, ZU-PBOX-LAN
Warranty:	2 years from date of purchase at bmcm, claims for damages resulting from improper use excluded

Manufacturer: BMC Messsysteme GmbH. Subject to change due to technical improvements. Errors and printing errors excepted. Rev. 4.0 12/23/2010